

STI14120FR

STI Low Profile Universal Stopper[®]



KEY FEATURES

General Information

- These indoor and outdoor low profile polycarbonate covers can protect a variety of devices without restricting legitimate operation.
- Three year guarantee against breakage of polycarbonate in normal use (one year on electromechanical and electronic components).

Design

- Prevents false alarms, without hindering legitimate operation of a manual call point in the event of an emergency.

Construction

- Tough polycarbonate housing can withstand severest of knocks.

Installation

- A simple 4 fixing installation can retrofit over existing device.
- Can accommodate flush or surface mount applications.
- Typical working properties of polycarbonate are -40° to 121°C (-40° to 250°F).

Electronics

- Available with or without a 95 dB sounder, powered by a 3V CR123A battery. The sounder draws immediate attention to the area.
- Sounder cartridge has an LED light for an extra visual deterrent.
- Optional 12-24 VDC powered units.

Options

- One breakseal is supplied with each model. Additional breakseals are available for added security.
- Available in a range of colours.
- Custom labelling available.

PRODUCT OVERVIEW

These indoor and outdoor low profile polycarbonate covers protect devices such as manual call points, emergency buttons and dual action pull stations etc., without restricting legitimate operation. The versatile cover offers excellent protection against physical damage (both accidental and intentional), dust and grime as well as severe environments inside and out. The Low Profile Universal Stopper with optional sounder comes with a new LED light in the hood for an extra visual deterrent.

IMPORTANT NOTICE

When used on fire systems, Universal Stopper is intended for areas where the incidence of false fire alarms from manual call points is high or has proven to be a serious problem. Any disadvantage of the device is more than balanced when one considers the consequences of false fire alarms, especially if fire service personnel and equipment are responding to a false fire alarm when they are needed for a real fire somewhere else. Add to this the disruption to the facility when false alarms occur. If you have, or may have, a problem with false fire alarms or physical/weather damage to your fire alarm activation devices, the Universal Stopper could prove invaluable.

STI Low Profile Universal Stopper®

Dimensions and Technical Information

EXTERNAL DIMENSIONS (mm):

Mounting Option	Height	Width	Depth
Flush	207	137	50
Surface	207	137	88
Enclosed Flush Back Box	207	137	53
Enclosed Back Box	207	137	84

DIMENSIONS:

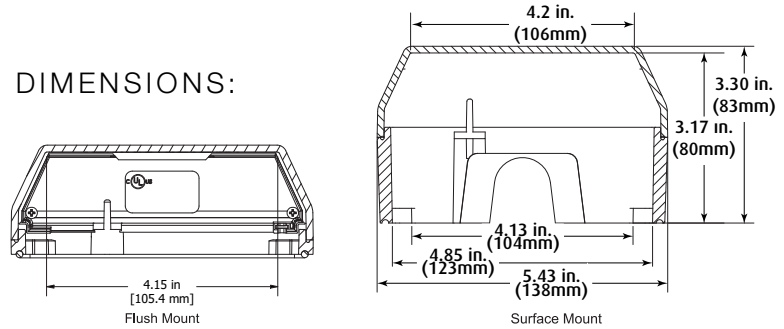

APPROVALS

TESTED AND APPROVED OR LISTED BY:
 · UL/cUL Listed No. S2466

NB: When installed correctly, mounting options 0 and 1 are designed to meet the requirements of IP54. Mounting option 6 meets the requirements of IP66, and mounting option 7 meets the requirements of IP56.

